

2019

HEAT, LIFE AND ATMOSPHERE

A real fire is a beautiful and romantic source of heat which creates a warm, cosy atmosphere. There is nothing quite like settling down and watching the flames flickering in the stove as a comfortable warmth spreads throughout the room. A real wood burning stove is an integral part of a home, and provides a wonderful focal point for the entire family during the colder months of the year.



WESTFIRE

THE ART OF DANISH ENGINEERING



ecodesign
ready

ATTENTION TO **DETAIL**

When the weather outside begins to chill, a stove naturally becomes the heart of the home. A centre focal point for all the family, it is essential to choose a brand you can trust. Westfire stands for high quality craftsmanship and impeccable attention to detail; leaving you safe in the knowledge that your stove will last for many years, performing to the highest levels of efficiency and environmental standards. When correctly used with well managed wood, your stove will be CO₂-neutral making it a responsible option for a renewable energy source. For a functional and highly efficient stove with a focus on design, Westfire is the perfect choice.



WESTFIRE.UNIQ.28 / BLACK WITH SOAPSTONE 4,4 kW ✓



WESTFIRE.UNIQ.32 / INSERT / WF / FULL GLASS FRONT 5,9 kW ✓



CAREFULLY DESIGNED FOR WARMTH

Westfire designs stoves with great care and attention to detail. A wood burning stove must complement the home in which it is installed since it will outlast both the furniture and the décor. Westfire has therefore developed a future-proof design characterised by simplicity, timelessness and contemporary technology.

Using a wood burning stove to heat your home is a natural process which does not contribute to the greenhouse effect. Westfire's stoves make effective use of thermal energy and are very environmentally friendly.

A stove brings the family closer – all members, young and old, can work together to split logs, bring in firewood and feed the fire. And the whole family can enjoy the great indoor climate and the natural heat produced by a wood burning stove.



WESTFIRE.UNIQ.32 / INSERT / NF / FULL GLASS FRONT 5,9 kW ✓

ecodesign
ready

 WESTFIRE.UNIQ.37 / BLACK 7,2 kW 



ecodesign
ready



WESTFIRE.UNIQ.37 / BLACK WITH PEDESTAL 1

7,2 kW





NEW



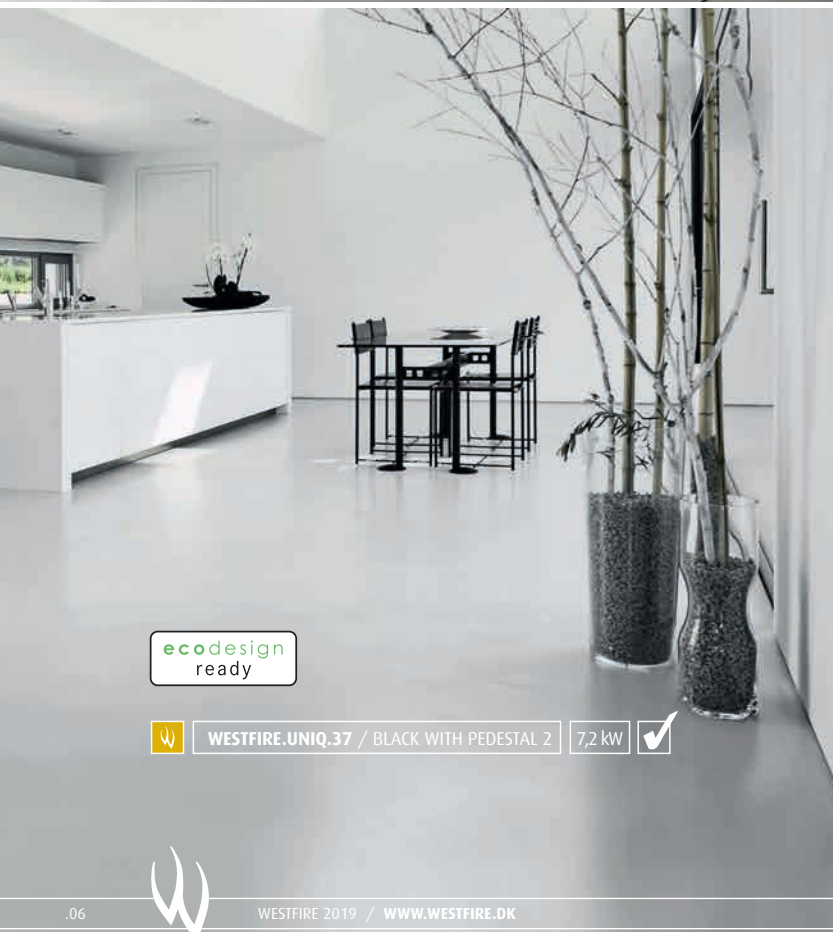

ecodesign
ready

 WESTFIRE.UNIQ.37 / BLACK WALL-MOUNTED 7,2 kW 



ecodesign
ready

 WESTFIRE.UNIQ.37 / BLACK WITH PEDESTAL 2 7,2 kW 



ecodesign
ready

NEW



WESTFIRE.UNIQ.37 LARGE / BLACK

7,2 kW



ecodesign
ready

NEW



WESTFIRE.UNIQ.36 / BLACK

7,2 kW



ecodesign
ready

NEW



WESTFIRE.UNIQ.36 / BLACK WITH PEDESTAL 1

7,2 kW





NEW



ecodesign
ready



 WESTFIRE.UNIQ.36 / BLACK WALL-MOUNTED 7,2 kW 



NEW



ecodesign
ready

 WESTFIRE.UNIQ.36 / BLACK WITH PEDESTAL 2 7,2 kW 





WESTFIRE.UNIQ.35 / ON 50 MM BLOCK

4,3 kW



ecodesign
ready



WESTFIRE.UNIQ.33 / SIDE GLASS / BLACK

6,1 kW



WESTFIRE UNIQ 28 WITH HEAT STORAGE SYSTEM

The Westfire Uniq 28 heat storage stove gently absorbs heat from your stove whilst it is operating. Heat storage is the combination of the wood-burning stove's ability to quickly and comfortably distribute the convection heat and the mass stove's ability to store the heat, so when the stove has burnt out the stove will continue to slowly dissipate heat long after the fire's heat has died down*. This type of system is perfect for maintaining a steady heat flow in your home, avoiding the necessity of burning your appliance continually.

*The time span the heat will be dissipated is dependent on stone temperature and room temperature and size.



WESTFIRE.UNIQ.28 / BLACK WITH SOAPSTONE

4,4 kW



HEAT OUTPUT GRAPH*

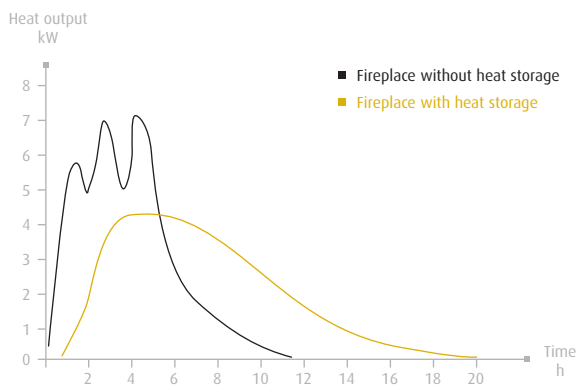

*Results after performance from three burn cycles of standard test load weights.





WESTFIRE. UNIQ.28 / BLACK

4,4 kW



WESTFIRE. UNIQ.27 / BLACK

4,4 kW



WESTFIRE. UNIQ.26 / BLACK WITH SOAPSTONE

4,4 kW



WESTFIRE. UNIQ.27 / BLACK WITH SOAPSTONE

4,4 kW





WESTFIRE.UNIQ.26 / BLACK

4,4 kW





WESTFIRE.UNIQ.26 LARGE / BLACK

4,4 kW





QUALITY STOVES IN LINE WITH THE LATEST TECHNOLOGY



Westfire has developed a complete range of wood burning stoves, flue pipes, chimneys and accessories recognisable by their clean lines. All Westfire's products are manufactured in accordance with the finest traditions of craftsmanship. The stoves incorporate the latest combustion technology, which ensures economical and clean combustion. Westfire's stoves are available with top or back flue outlets, making them suitable for new and older buildings alike.





 WESTFIRE.UNIQ.23 / SIDE GLASS / PEDESTAL 3 5,3 kW 



 WESTFIRE.UNIQ.23 / CURVED DOOR / SIDE GLASS / PEDESTAL 5 5,3 kW 





WESTFIRE.UNIQ.23 / PEDESTAL 5 ON STAND

5,3 kW





 WESTFIRE.UNIQ.23 / CURVED DOOR / PEDESTAL 2 5,3 kW 

UNIQ 23 FEATURES

- Large glass area
- Clean burn technology
- Primary, secondary and tertiary air
- Closed combustion air supply
- Efficient convection stove
- Ash pan



 WESTFIRE.UNIQ.23 / CURVED DOOR 5,3 kW 



WESTFIRE.UNIQ.23 / BLACK

5,3 kW





WESTFIRE.UNIQ.21 / BLACK WITH PEDESTAL

5,0 kW





WESTFIRE.UNIQ.21 / BLACK

5,0 kW



BEAUTIFUL SOLUTIONS THAT **WORK**

Westfire is a tried-and-tested concept, with attention paid to every detail. We have many years' experience in the development of exciting and functional solutions for the home. We offer both hearth plates and chimneys to complement our range of stunning wood burning stoves, making it easy to create a stylish and exclusive look in your home.





WESTFIRE.UNIQ.21 / BLACK WALL-MOUNTED

5,0 kW





WESTFIRE.UNIQ.18 / BLACK WITH DOOR

5,0 kW





WESTFIRE.UNIQ.18 / BLACK

5,0 kW





WESTFIRE.UNIQ.17 / BLACK

5,0kW





WESTFIRE.UNIQ.15 / BLACK

5,0 kW



ECONOMIC ADVANTAGES

Using wood to heat your home can yield huge savings, and it is often possible to recoup the investment in a new wood burning stove over a very short period of time. It is important to choose the right size of stove, and to position it correctly within the house, in order to obtain the greatest possible benefit from the heat which is emitted. Westfire has developed many different types of wood burning stoves, all available in different sizes with a range of options. Which, of course, means that you will get the most advantageous solution, whatever your requirements.



WESTFIRE.ONE / PEDESTAL

4,9 kW





WESTFIRE.ONE / BLACK

4,9 kW





WESTFIRE.TWO / BLACK

7,1 kW



WESTFIRE.TWO / PEDESTAL

7,1 kW





 WESTFIRE.UNIQ.35 / INSERT

4,3 kW 



 WESTFIRE.UNIQ.35 / INSERT / 3-SIDED FRAME

4,3 kW 

WESTFIRE INSET STOVES

A Westfire Inset stove is designed to fit beautifully into a wall, providing efficient heat and adding a touch of style to your living space. Westfire have created a range of inset stoves with dimensions to suite your requirements.

Uniq 35 – is a 400 mm wide body, designed to fit into a British fireplace which can be installed with a 3 or 4 sided frame.

Uniq 23 – is a 600 mm wide body, it is available in new flat or curved door variants which can be installed with a 3 or 4 sided frame.

Uniq 32 – is a 800 mm wide body, it is available in steel or glass front variants which can be installed with wide 4 sided or narrow 4 sided frame options. All models have direct air options.



WESTFIRE.UNIQ.23 / INSERT / CURVED DOOR

5,3 kW

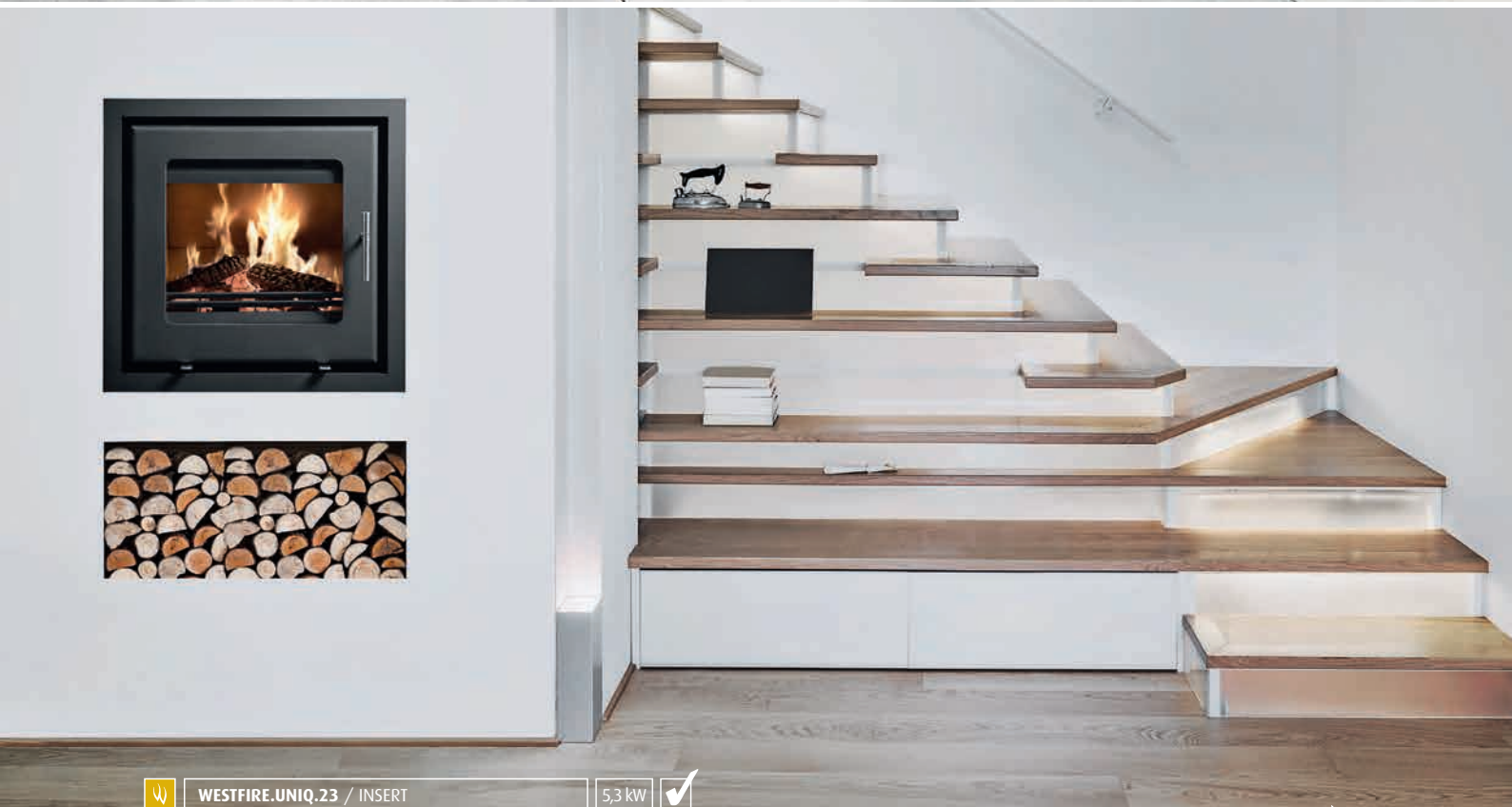

WESTFIRE.UNIQ.23 / INSERT

5,3 kW





WESTFIRE.UNIQ.32 / INSERT / WF / FULL GLASS FRONT

5,9 kW





WESTFIRE.UNIQ.32 / INSERT / NF / FULL GLASS FRONT

5,9 kW



STUNNING **DESIGN** AND A COMFORTABLE CLIMATE

Westfire manufactures a range of highly functional wood burning stoves that meet the most stringent requirements for environmentally friendly combustion. Convection stoves heat the air and spread it evenly throughout the room. At Westfire, you can choose the stove that best matches your requirements. Whatever your choice of Westfire stove, you are guaranteed an efficient and economical source of heat.





WESTFIRE.UNIQ.32 / INSERT / WIDE FRAME

5,9 kW





WESTFIRE.UNIQ.32 / INSERT, NARROW FRAME

5,9 kW





WESTFIRE HEARTH PLATES

	STANDARD PLATE SMALL	STANDARD PLATE MEDIUM	STANDARD PLATE BIG	TEARDROP SHAPED PLATE	TEARDROP SHAPED PLATE	TRUNCATED PLATE	SQUARE PLATE	RECTANGULAR PLATE
WF STEEL PLATES 2 mm			 Product no. 5015	 Product no. 5011				
WF SLATE PLATES 20 mm		 Product no. 5007 (G)	 Product no. 5005 (G)	 Product no. 5001 (G)				
WF GLASS PLATES 12 mm Hardened glass		 Product no. p19	 Product no. p6		 Product no. p15	 Product no. p14	 Product no. p13	 Product no. p18
WF GLASS PLATES 6 mm Hardened glass	 Product no. p16		 Product no. p6	 Product no. p11	 Product no. p15	 Product no. p14	 Product no. p13	

(G) = Available in grey

WESTFIRE FLUE PIPE SETS

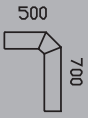
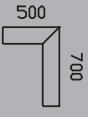
All flue pipes from Westfire are made of 2 mm high-grade steel and are available with a black or grey lacquered finish. All flue pipe sets are supplied with a short wall sleeve and one rosette (decorative ring). Internal pipe diameter: 150 mm.

	PRODUCT NUMBER	DESCRIPTION	STANDARD DIMENSIONS
	9005 (G)	Flue pipe set 2 x 45°	700 x 500 mm
	9101 (G)	Flue pipe set 90°	700 x 500 mm
	9103 (G)	90° soft bend flue pipe	700 x 500 mm

(G) = Grey



WESTFIRE DIGITAL MOISTURE METER



WESTFIRE FLUE PIPES

No.	Product no.	Description	Standard dimensions
1	9002 (G)	Flue pipe, 45° elbow	26 x 31 cm
3	9003 (G)	Flue pipe, 45° elbow, short	14 x 14 cm
	9015 (G)	Flue pipe extension	15 cm
4	9025 (G)	Flue pipe extension	25 cm
5	9033 (G)	Flue pipe extension	33 cm
6	9050 (G)	Flue pipe extension	50 cm
7	9100 (G)	Flue pipe extension	100 cm
8	9110	Wall sleeve, short	10 cm
9	9111	Wall sleeve, long	29 cm
10	9113 (G)	Rosette	-
11	9114	Flue damper	-
12	9100	Connector piece	-
13	0090 (G)	0-90° swivel elbow	-
	9113(G)	Rosette 45 gr.	-
	9100	Flue pipe extension w/door	100 cm
	9050	Flue pipe extension/adjustable	50 cm
	9100S(G)	Starter pipe	100 cm
	9010 (G)	Starter pipe	10 cm

(G) = Grey

WESTFIRE CHIMNEYS













No. Description

- 1 Starter pipe, uninsulated
- 2 Chimney section, insulated, with connector
- 3 Roof flashing
- 4 Ceiling collar
- 5 Chimney cowl (mounted on chimney section)
- 6 Connector



Westfire's sectional chimneys are CE approved (minimum distance to combustible materials 25 mm).

TECHNICAL DATA

	TESTED OUTPUT	RECOMMENDED AREA	LOADING DOOR (LOG LENGTH)	TESTING				DISTANCE COMBUSTIBLE REAR	DISTANCE COMBUSTIBLE SIDES	ENERGY
				CE	SINTEF	EN	DEFRA			
WESTFIRE.UNIQ.15	5,0 kW	30-100 m ²	30 cm	●	●	●	●	15 cm	35 cm	
WESTFIRE.UNIQ.17 / WESTFIRE.UNIQ.18	5,0 kW	30-100 m ²	32 cm	●	●	●	●	17,5 cm	35 cm	
WESTFIRE.UNIQ.21 WESTFIRE.UNIQ.21 WALL-MOUNTED WESTFIRE.UNIQ.21 PEDESTAL	5,0 kW	30-100 m ²	30 cm	●	●	●	●	17,5 cm	30 cm	
WESTFIRE.UNIQ.23 STANDARD LEGS 100 MM WESTFIRE.UNIQ.23 PEDESTAL 1 WESTFIRE.UNIQ.23 PEDESTAL 2 WESTFIRE.UNIQ.23 PEDESTAL 3 WESTFIRE.UNIQ.23 PEDESTAL 5 WESTFIRE.UNIQ.23 INSERT 4-SIDED WESTFIRE.UNIQ.23 INSERT 3-SIDED	5,3 kW	40-110 m ²	40 cm	●	●	●	●	20 cm	35 cm/ 45 cm SG	
WESTFIRE.UNIQ.26 / WESTFIRE.UNIQ.26 LARGE WESTFIRE.UNIQ.27 / WESTFIRE.UNIQ.28	4,4 kW	30-100 m ²	30 cm	●	●	●	●	10 cm	30 cm	
WESTFIRE.UNIQ.32 INSERT (NARROW FRAME) WESTFIRE.UNIQ.32 INSERT (WIDE FRAME)	5,9 kW	50-150 m ²	65 cm	●	●	●	●	20 cm	15 cm	
WESTFIRE.UNIQ.33 SIDE GLASS	6,1 kW	50-150 m ²	33 cm	●	●	●	●	20 cm	45 cm	
WESTFIRE.UNIQ.35 50 MM BLOCK WESTFIRE.UNIQ.35 INSERT, 4-SIDED WESTFIRE.UNIQ.35 INSERT, 3-SIDED	4,3 kW	30-100 m ²	29 cm	●	●	●	●	20 cm	20 cm	
WESTFIRE.UNIQ.36 WESTFIRE.UNIQ.36 WALL-MOUNTED WESTFIRE.UNIQ.36 PEDESTAL 1 WESTFIRE.UNIQ.36 PEDESTAL 2	7,2 kW	50-100 m ²	35 cm	●	●	●	●	17,5 cm	45 cm	
WESTFIRE.UNIQ.37 WESTFIRE.UNIQ.37 WALL-MOUNTED WESTFIRE.UNIQ.37 LARGE WESTFIRE.UNIQ.37 PEDESTAL 1 WESTFIRE.UNIQ.37 PEDESTAL 2	7,2 kW	50-100 m ²	35 cm	●	●	●	●	10 cm	60 cm	
WESTFIRE.ONE / WESTFIRE.ONE PEDESTAL	4,9 kW	30-100 m ²	30 cm	●	●	●	●	10 cm	55 cm	
WESTFIRE.TWO / WESTFIRE.TWO PEDESTAL	7,1 kW	50-150 m ²	42 cm	●	●	●	●	45 cm	60 cm	

Flue Outlet: Top and Rear flue outlet suitable for 125 mm single wall pipe with internal placement.
Flue Collar is also suitable for 150 mm ID Flue pipe with external placement where regulations allow.

ecodesign
ready

Ecodesign is the European-wide program to lower emissions. It is due to come into force in 2022. Westfire stoves have created new stoves that will meet the lower emission limits set out in the new standard now, so you can be comfortable that your new stove is one of the cleanest burning in the market today.



Westfire combustion chambers are very efficient and designed to burn cleanly. Stoves displaying the tick logo are approved for burning wood in a smoke control area, special note should be taken to the manufacturer's instructions on burning stoves in a smoke control zone. Wood burnt should be split and dry and have a moisture content of 15% or below and be free of chemical treatments.

When purchasing a Westfire stove please request a DEFRA approved model to ensure you receive an approved stove.



ENERG Y UA
енергия · енерує · енергя · енергя

IE IA





WESTFIRE

UNIQ.17 / UNIQ.18





5,0
kW

ENERGIA · ЕНЕРГИЯ · ΕΝΕΡΓΕΙΑ · ENERGIJA · ENERGY · ENERGIE · ENERGI

2015/1186

MODELS

WESTFIRE.UNIQ.15
WEIGHT: 110 KG

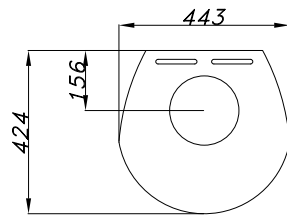
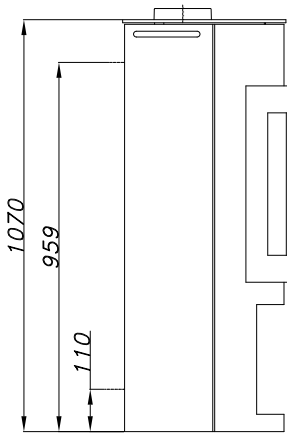

WESTFIRE.UNIQ.17
WEIGHT: 84 KG

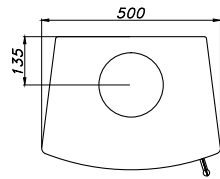
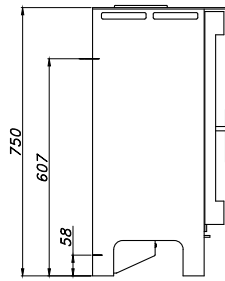

WESTFIRE.UNIQ.18
WEIGHT: 92 KG

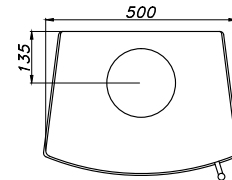
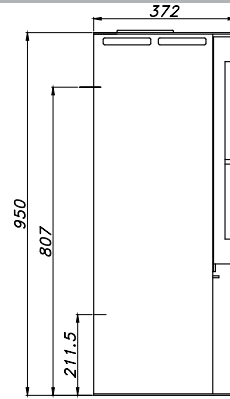

WESTFIRE.UNIQ.21
WEIGHT: 81 KG

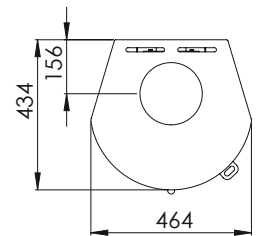
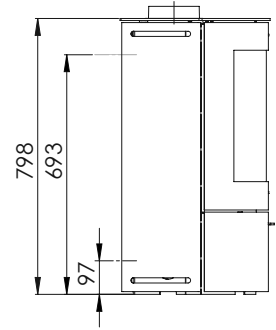

WESTFIRE.UNIQ.21 / WALL-MOUNTED
WEIGHT: 81 KG

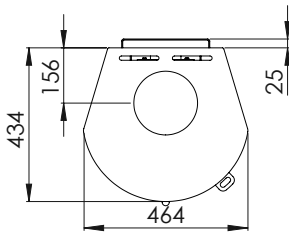
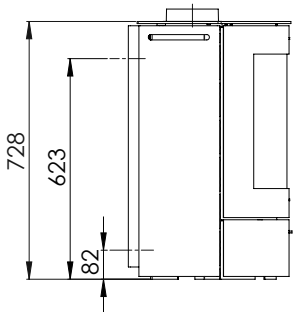

WESTFIRE.UNIQ.21 / PEDESTAL
WEIGHT: 91 KG

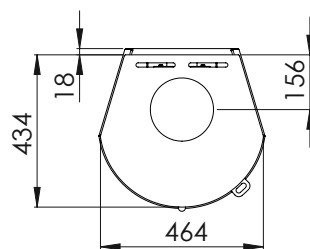
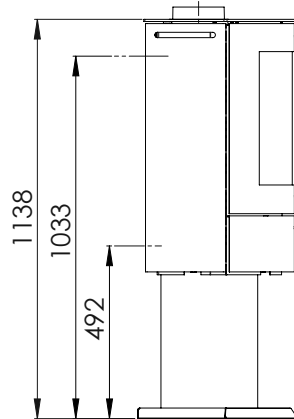

WESTFIRE.UNIQ.23
FLAT / CURVED DOOR
WEIGHT: 92 KG

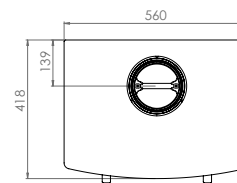
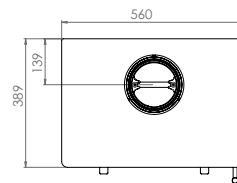
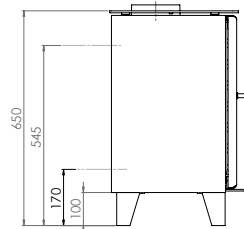

WESTFIRE.UNIQ.23
PEDESTAL 1 / PEDESTAL 2
FLAT / CURVED DOOR / WEIGHT: 112 KG

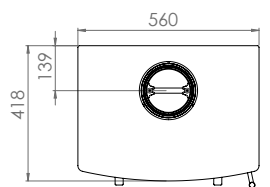
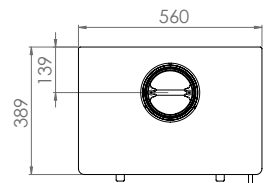
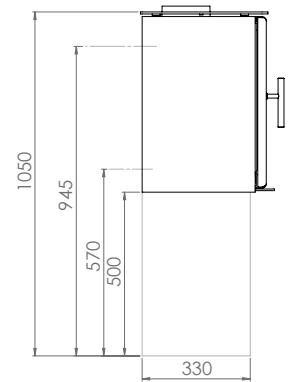

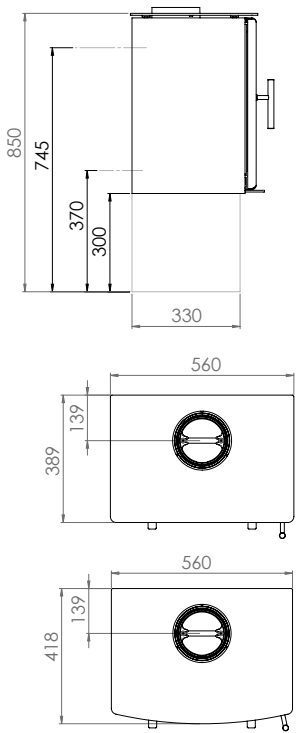
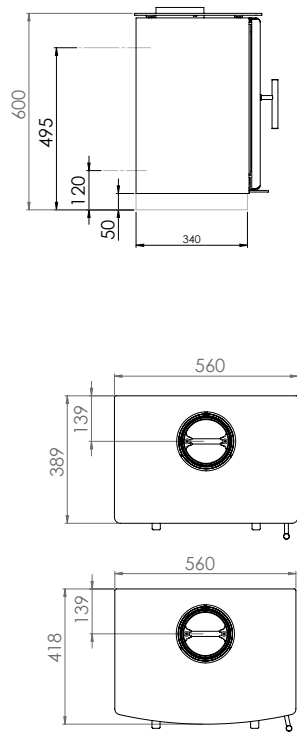
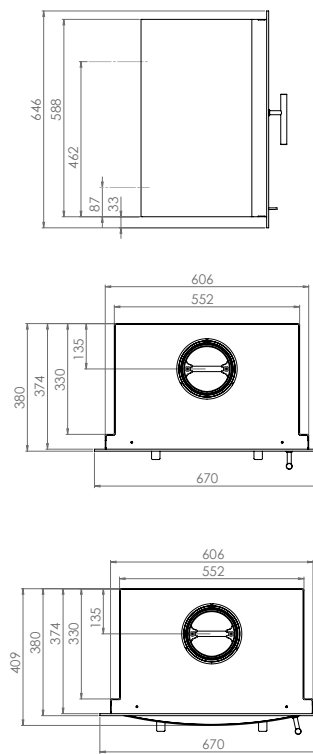
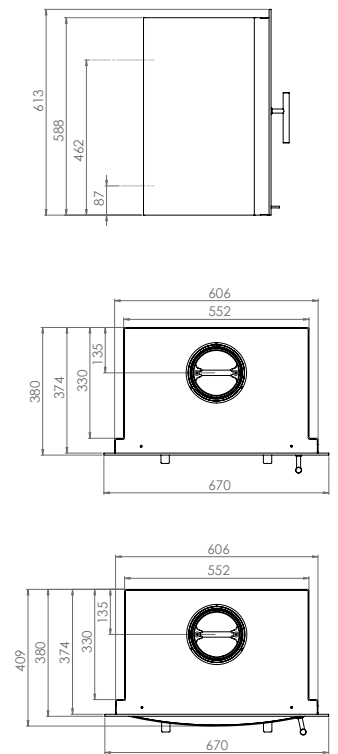
WESTFIRE.UNIQ.23 / PEDESTAL 3FLAT / CURVED DOOR
WEIGHT: 112 KG**WESTFIRE.UNIQ.23 / PEDESTAL 5**FLAT / CURVED DOOR
WEIGHT: 92 KG**WESTFIRE.UNIQ.23 INSERT 4-SIDED FRAME**FLAT / CURVED DOOR
WEIGHT: 92 KG**WESTFIRE.UNIQ.23 INSERT 3-SIDED FRAME**FLAT / CURVED DOOR
WEIGHT: 92 KG**WESTFIRE.UNIQ.26**

WEIGHT: 105 KG

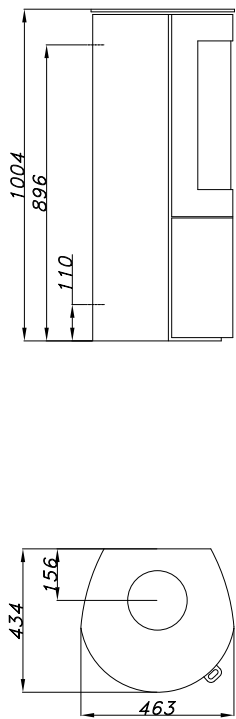
**WESTFIRE.UNIQ.26 L**

WEIGHT: 120 KG

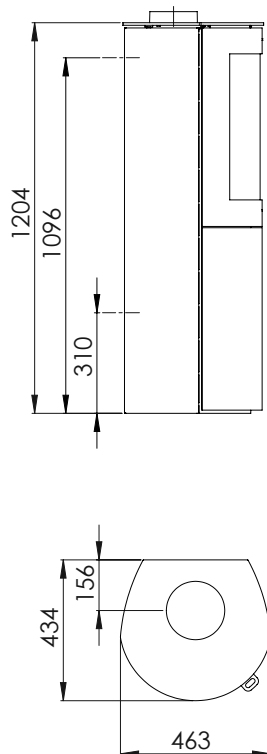
**WESTFIRE.UNIQ.27**

WEIGHT: 110 KG

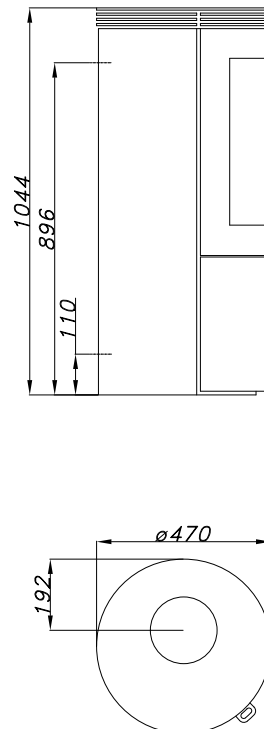
**WESTFIRE.UNIQ.28**

WEIGHT: 120 KG

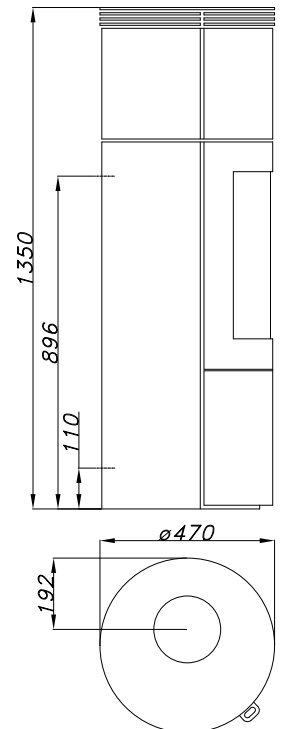

MODELS

WESTFIRE.UNIQ.32 / INSERT
NARROW 4-SIDED FRAME
WEIGHT: 110 KG

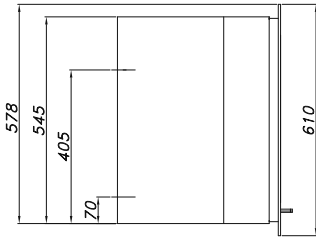

WESTFIRE.UNIQ.32 / INSERT
WIDE 4-SIDED FRAME
WEIGHT: 110 KG

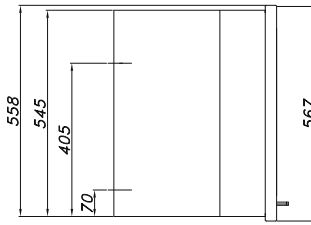

WESTFIRE.UNIQ.33 / SIDEGLASS
WEIGHT: 118 KG

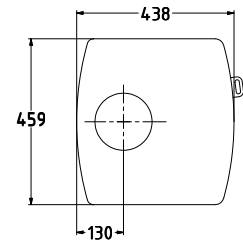
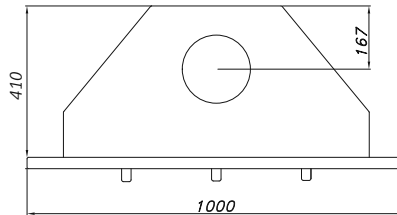
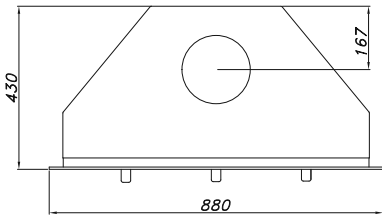
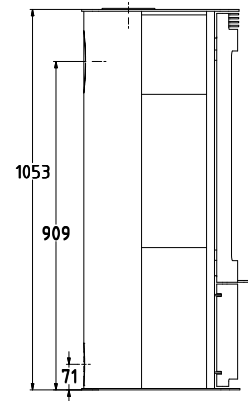

WESTFIRE.UNIQ.35 / 50 MM BLOCK
WEIGHT: 95 KG

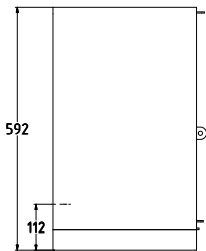

WESTFIRE.UNIQ.35 / INSERT
4-SIDED FRAME
WEIGHT: 75 KG

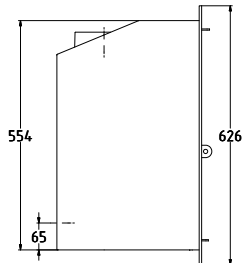

WESTFIRE.UNIQ.35 / INSERT
3-SIDED FRAME
WEIGHT: 75 KG

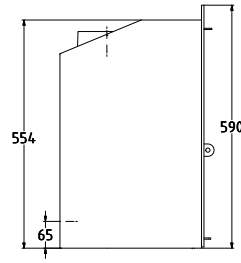

WESTFIRE.UNIQ.36
WESTFIRE.UNIQ.37
WEIGHT: 90 KG

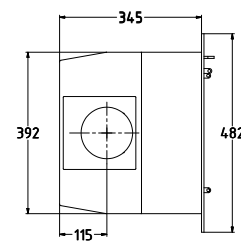
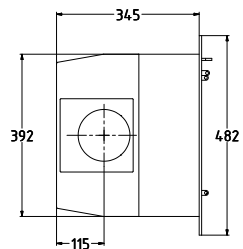
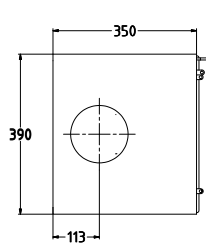
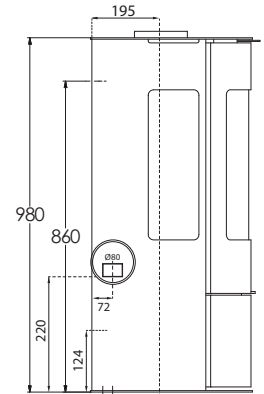

Optional closed combustion only on Westfire Uniq 37, Westfire Uniq 37 Pedestal 1 and Westfire Uniq 37 Pedestal 2

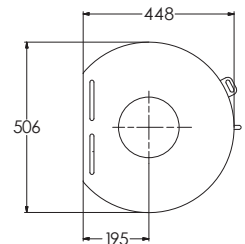

WESTFIRE.UNIQ.36
WESTFIRE.UNIQ.37
 WALL-MOUNTED / WEIGHT: 85 KG

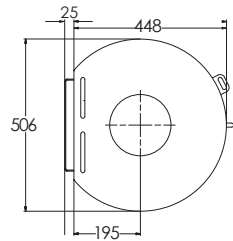
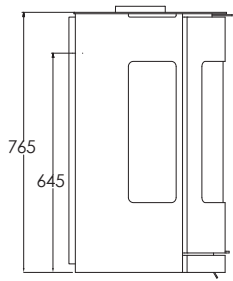

WESTFIRE.UNIQ.36
WESTFIRE.UNIQ.37
 PEDESTAL 1 / WEIGHT: 95 KG

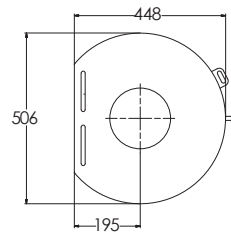
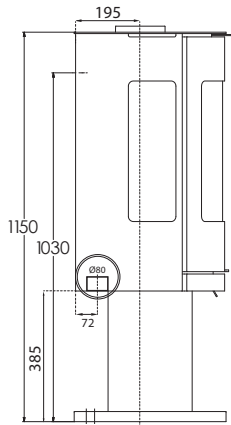

WESTFIRE.UNIQ.36
WESTFIRE.UNIQ.37
 PEDESTAL 2 / WEIGHT: 95 KG

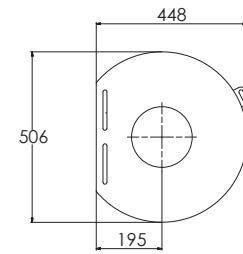
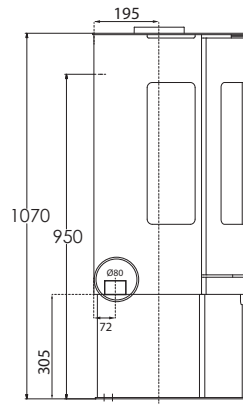

WESTFIRE.UNIQ.37 / LARGE
 WEIGHT: 110 KG

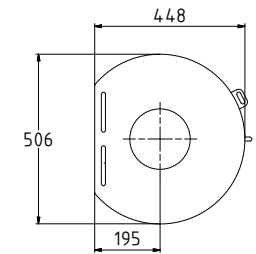
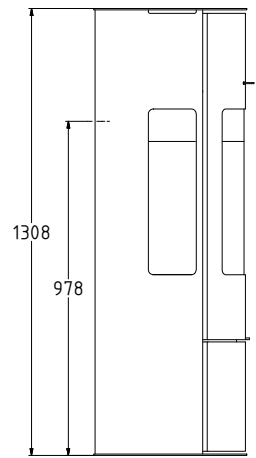

WESTFIRE.ONE
 WEIGHT: 80 KG

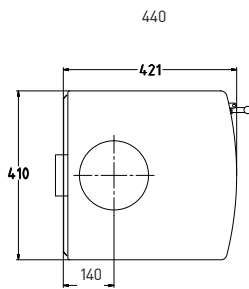
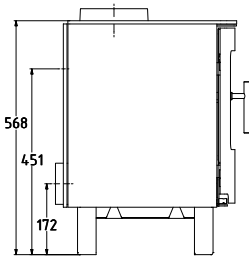

WESTFIRE.ONE / PEDESTAL
 WEIGHT: 110 KG

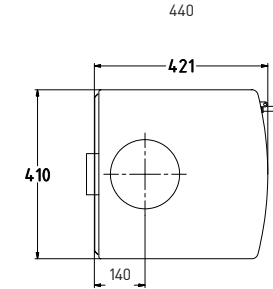
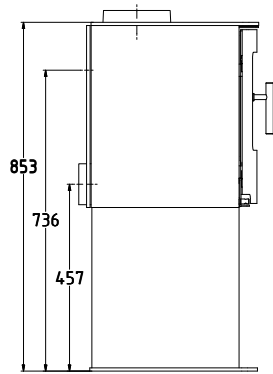

WESTFIRE.TWO
 WEIGHT: 100 KG

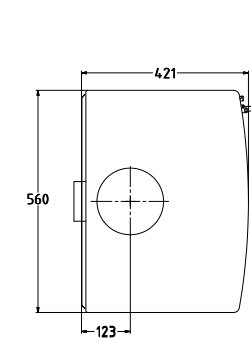
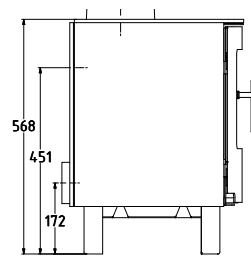

WESTFIRE.TWO / PEDESTAL
 WEIGHT: 135 KG

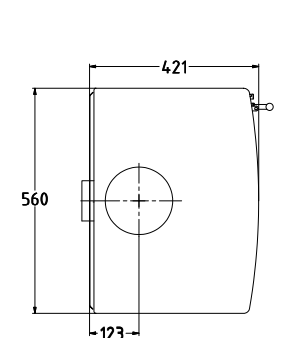
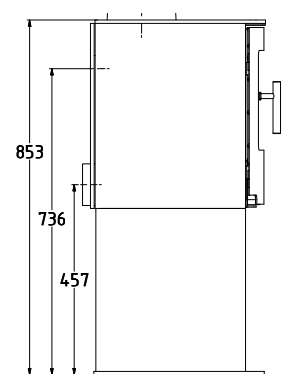



 WESTFIRE.UNIQ.32 / INSERT, NARROW FRAME

 WESTFIRE / CONVECTION GRILL FOR INSERT

 WESTFIRE.UNIQ.32 / INSERT

QUALITY YOU CAN FEEL

All wood burning stoves from Westfire carry the CE mark. A CE/EN approval means that the stoves have been tested and approved by the Danish Technological Institute in accordance with EN 13240. The CE mark is your guarantee that the stove meets a number of stringent requirements as regards safety, the environment and fuel economy. Westfire stoves are characterised by a number of technical advantages that ensure their long durability, high heating efficiency and reliable operation.

Fuel types

Westfire stoves are accredited for burning wood and CE marked for this purpose. Although the appliances will burn other fuels Westfire do not recommend the use such fuels in our appliances.



TØMRERVEJ 3 / DK-6800 VARDE / TEL. +45 7522 5352 / FAX +45 7522 1352 / E-MAIL: INFO@WESTFIRE.DK / WWW.WESTFIRE.DK

DISTRIBUTOR

